

## AS01808MR-R 18mm Speaker



3541 Stop Eight Road • Dayton, Ohio 45414

### Product Overview

- 18mm diameter speaker with Neodymium magnet for 80 dB sensitivity
- 1W continuous, 1.5W maximum power handling and 8Ω impedance
- Mylar cone with polyurethane surround for durability and moisture resistance

Frequency Response (1W @ 0.5 meters)

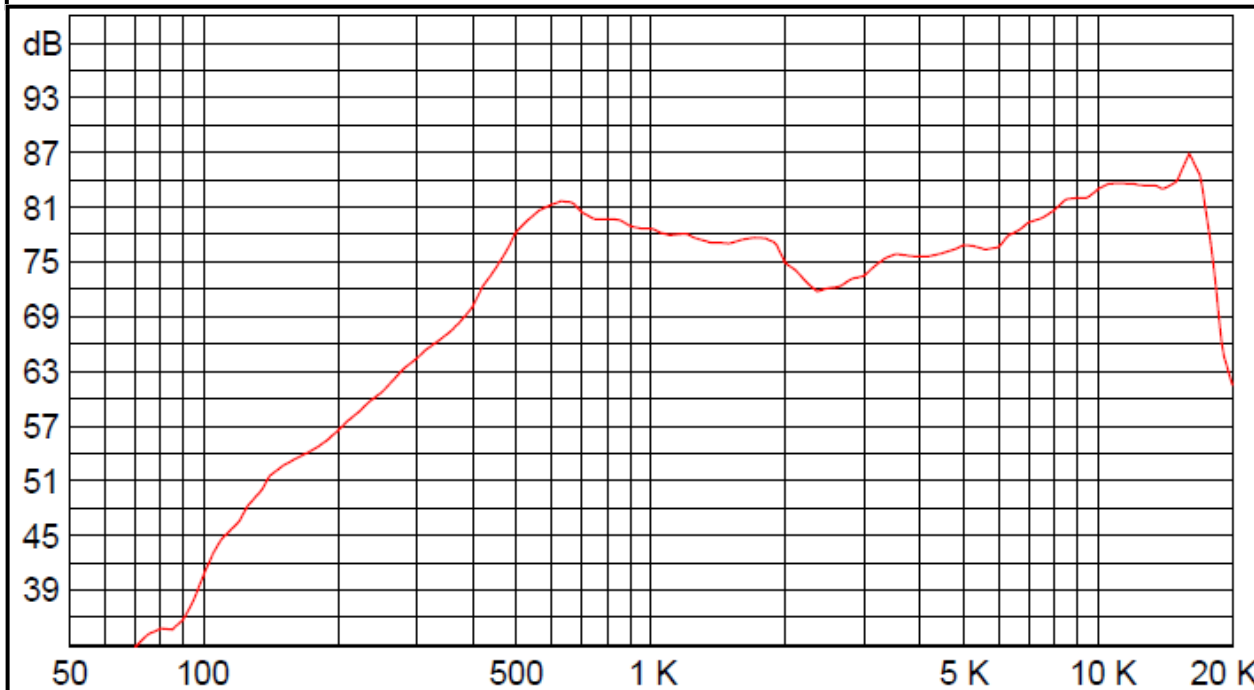

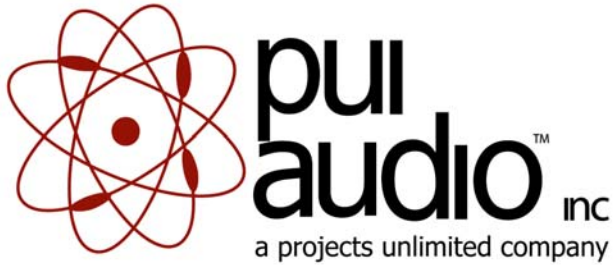

# AS01808MR-R 18mm Speaker

## Mechanical and Environment Testing

Test Description	Test Condition
High Temperature	60°C ±2°C with random humidity for 96 hours
Low Temperature	-25°C ±2°C with random humidity for 96 hours
Humidity	40°C with 90% to 95% relative humidity for 96 hours
Vibration	1.5 mm movement modulated at 10 to 55 Hz for 2 hours
Drop Test	75 cm free fall onto concrete floor, 10 cycles
Temperature Cycle Test	-20°C to 55°C, 5 cycles (refer to Temperature Cycle Test Graph)

After tests, speaker shall rest for 1 hours. SPL shall not deviate ±4 dB from pre-test measurement.

## Temperature Cycle Test Graph

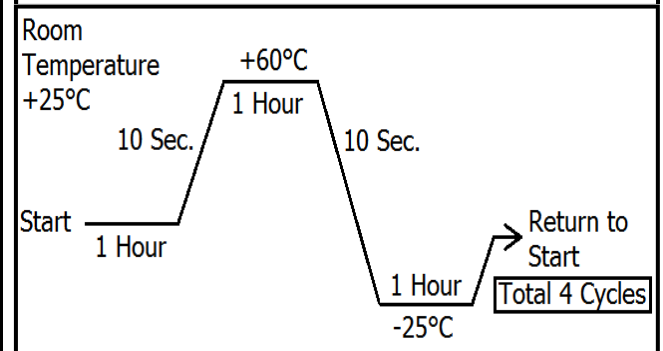

## Thiele-Small Parameters

Specification	AS01808MR-R
Fo (Hz)	505.9
Qes	3.695
Qms	2.302
Qts	1.418
Vas (mm <sup>3</sup> )	3.1k
Sd(mm <sup>2</sup> )	156
Mms(g)	0.110
Xmax (mm)	1.5
Re (ohm)	8.39
SPL (dB) @ 1W/1m	72.39
BL (T)	0.89

## Frequency Response and SPL Measurement Setup

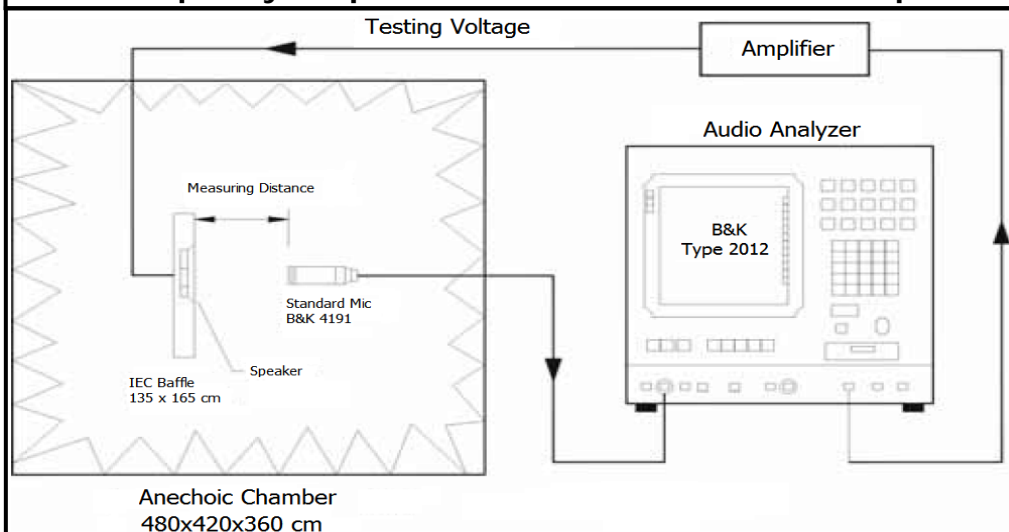

## SPECIFICATIONS

PARAMETERS	VALUES	UNITS
RATED INPUT POWER	1	W
MAX INPUT POWER	1.5	W
IMPEDANCE	8 ± 15%	OHM
OUTPUT SPL @ 1W/0.5M (AT 0.8, 1.0, 1.2, 1.5 kHz)	80 ± 3	dBa
DISTORTION (MAX.)	5%	-
RESONANT FREQUENCY	550~745	Hz
FREQUENCY RANGE	250 ~ 20,000	Hz
HOUSING MATERIAL	ABS	-
CONE MATERIAL	MYLAR	-
MAGNET MATERIAL	RARE EARTH	-
OPERATING TEMPERATURE	-25 ~ +60	°C
WEIGHT	2.8	grams

THIS DOCUMENT CONTAINS DATA PROPRIETARY TO PROJECTS UNLIMITED, INC. ANY USE OR REPRODUCTION, IN ANY FORM, WITHOUT PRIOR WRITTEN PERMISSION OF PROJECTS UNLIMITED, INC. IS PROHIBITED.  
©2003, Projects Unlimited Inc.

## REVISION HISTORY

LTR	DESCRIPTION	DATE	APPROVED
-	RELEASED FROM ENGINEERING	12/7/2005	
A	ADDED RoHS NOTE	11/4/2008	J.D.
B	REVISED TO INVENTOR 3-D DRAWING TEMPLATE	11/4/2008	B.R.
C	REVISED RESONANT FREQUENCY	8/25/2017	M.V.

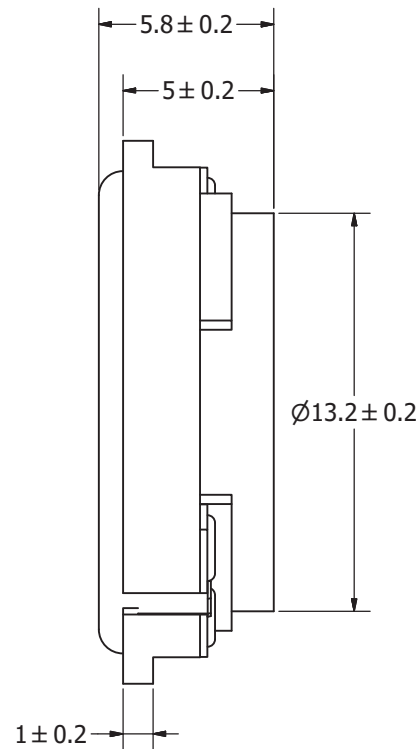
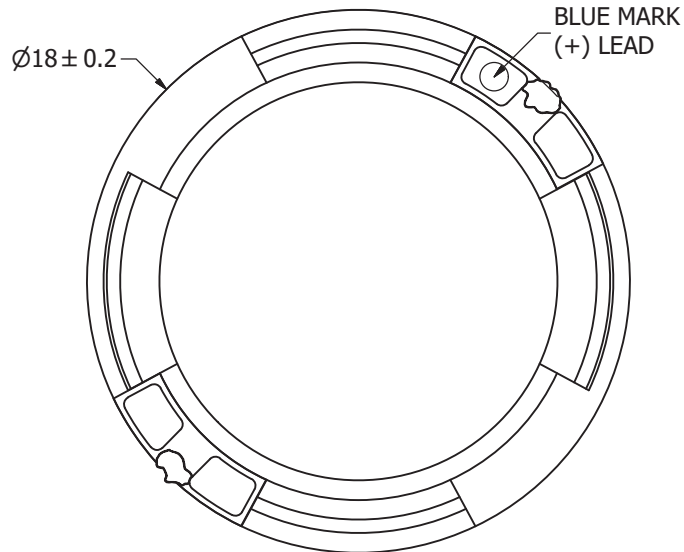

### NOTES:

1. ALL DIMENSIONS ARE IN MILLIMETERS.
2. SPECIFICATIONS SUBJECT TO CHANGE OR WITHDRAWAL WITHOUT NOTICE.
3. THIS PART IS RoHS 2002/95/EC COMPLIANT.

UNLESS OTHERWISE SPECIFIED: DIMENSIONS ARE IN MILLIMETERS, TOLERANCES ARE ±0.5 AND ANGLES ARE ±3°.	SIZE <b>A3</b>	Designed by	Date	Checked by	Date	Approved by	Date	Drawn Date
		J.D.	12/31/2007	X.X.	7/18/2007	X.X.	7/18/2007	11/4/2008
		 <b>pui audio</b> <small>a projects unlimited company</small>		<b>AS01808MR-R</b>			Edition	Sheet
Speaker				-	1 / 1			
AS01808MR-R.idw								